

AVVOLGIBILI   
**D'ERRICO**

ESTRUSIONE PROFILI TECNICI IN PVC



## AVVOLGIBILI

AVVOLGIBILI IN PVC	6
Tabella Colori	8
AVVOLGIBILI IN ALLUMINIO E ACCIAIO COIBENTATO	9
Tabella Colori	14
AVVOLGIBILI ARIALUCE	19
Tabella Colori	20
AVVOLGIBILI SICURTAPP	22
Tabella Colori	23

## ACCESSORI

AVVOLGITORI E PLACCHE	25
RULLI, PULEGGE E CALOTTE	33
SUPPORTI	36
GUIDACINTA E ACCESSORI VARI	38
ARGANELLI	43
ARGANI AD ASTA	45
ARGANI CORDA	46
TELAI A SPORGERE	47

## MOTORIDUTTORI

MOTORIDUTTORI E ACCESSORI	50
---------------------------	----

## PROFILI TECNICI

PROFILI TECNICI	55
-----------------	----



AVVOLGIBILI   
**D'ERRICO**



AVVOLGIBILI





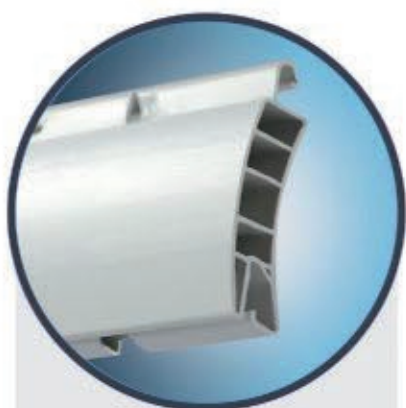

Peso al mq. Kg. 4,500x mq. +-5%  
Larghezza massima cm. 283  
Altezza massima cm. 290  
Pvc calcio zinco

## AVVOLGIBILE IN PVC 4.5

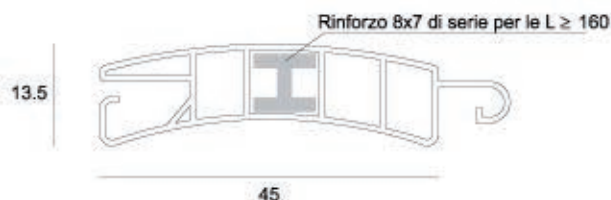

Codice	Descrizione
01001..	Avvolgibile PVC 4.5
01RIN00	Rinforzo ad H

### GUIDE COMPATIBILI

Codice	Descrizione
0808T00	Guida in ferro
08081..	Guida in alluminio 25x31
08082..	Guida in alluminio 20x30

tapparella in pvc (h)	120	130	140	150	160	170	190	210	230	240	250	260	270	280	290
ingombro Ø cm	16.5	16.5	18	18	18	19	20	20	21.5	21.5	22	22	23	23.5	23.5



Peso al mq. Kg. 6,000 x mq. +-5%  
Larghezza massima cm. 283  
Altezza massima cm. 290  
Pvc calcio zinco

## AVVOLGIBILE IN PVC 6.0

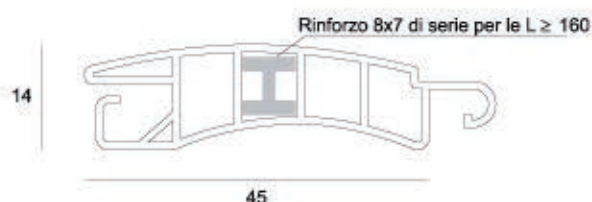

Codice	Descrizione
01601..	Avvolgibile PVC 6.0
01RIN00	Rinforzo ad H

### GUIDE COMPATIBILI

Codice	Descrizione
0808T00	Guida in ferro
08081..	Guida in alluminio 25x31
08082..	Guida in alluminio 20x30

tapparella in pvc (h)	120	130	140	150	160	170	190	210	230	240	250	260	270	280	290
ingombro Ø cm	18	19	19	20	20	21	22	23	24	24	25	25	25	26	26

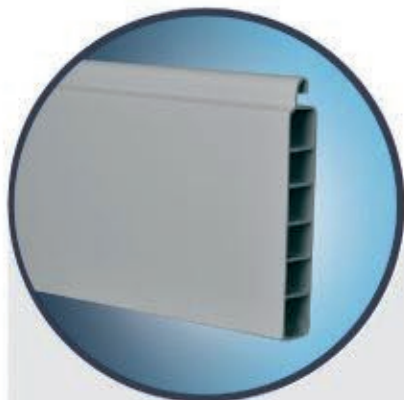

## AVVOLGIBILE IN PVC

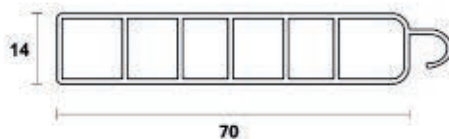

Codice	Descrizione
01002..	Terminale in PVC

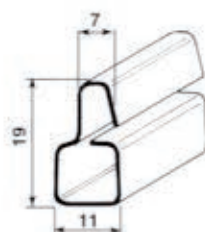

Codice	Descrizione
0100301	Terminale in ferro

## CARTELLA COLORI PVC

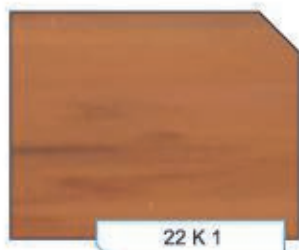
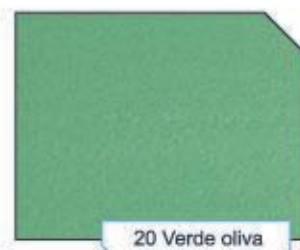
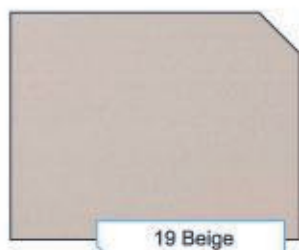
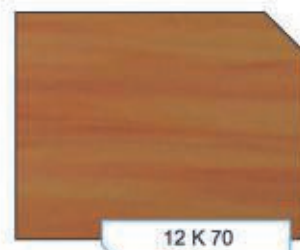
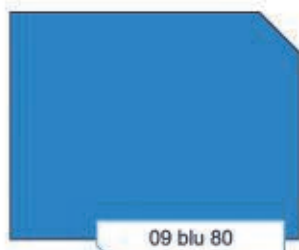
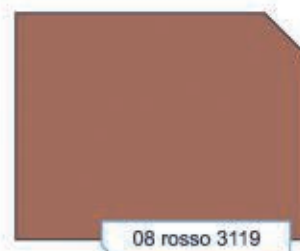
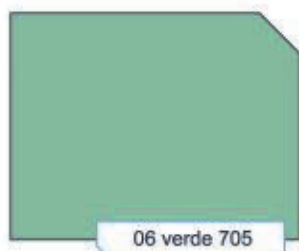

I colori stampati sono indicativi. Verificare sulle mazzette colori in PVC.



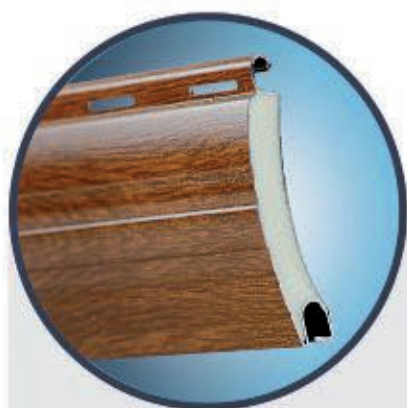

Peso al mq. Kg. 3,400 x mq. +-5% Densità Normale  
 Peso al mq. Kg. 5,00 x mq. Densità Alta  
 Larghezza massima cm 420  
 Altezza massima cm 330  
 Poliuretano Kg 70/90 x mq. Densità Normale  
 Poliuretano Kg 300/350 x mq. Densità Alta  
 Spessore lamiera 0,33 mm

## AVVOLGIBILE IN ALLUMINIO 12x55

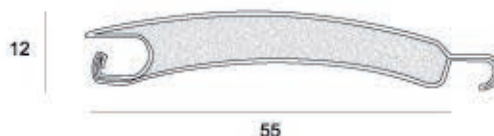

Codice	Descrizione
02055..	Avvolgibile in alluminio 12x55
02A55..	Avvolgibile in alluminio 12x55 con poliuretano ad alta densità
E2055..	Avvolgibile in alluminio con tappo avvolgente
E2A55..	Avvolgibile in alluminio con tappo avvolgente con poliuretano ad alta densità

### GUIDE COMPATIBILI

Codice	Descrizione
08081..	Guida in alluminio 25x31
08082..	Guida in alluminio 20x30
08083..	Guida in alluminio 17x28 (non compatibile con tappo avvolgente) vedi catalogo a pg 35-36



TAPPO  
AVVOLGENTE)

tapparella in all. (h)	120	130	140	150	160	170	180	190	200	220	240	250	260	270	280	290	300
ingombro Ø cm	15	16	17	17,5	17,5	18	18,5	18,5	19	20	21	21,5	21,5	22	22	23	24

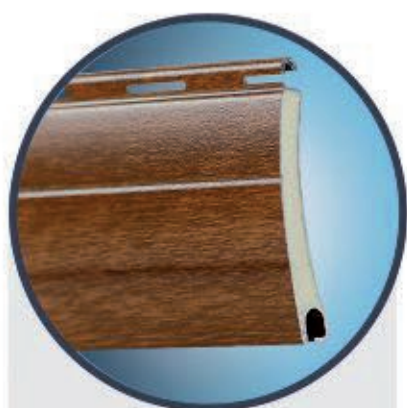

Peso al mq. Kg. 2,900 +-5%  
 Larghezza massima cm. 357  
 Altezza massima cm. 330  
 Poliuretano Kg 70/90 x mq  
 Spessore lamiera 0,33 mm

## AVVOLGIBILE IN ALLUMINIO 9x45



Codice	Descrizione
02043..	Avvolgibile in alluminio 9x45

### GUIDE COMPATIBILI

Codice	Descrizione
08084..	Guida in alluminio 20x25
08085..	Guida in alluminio 14x28

tapparella in all. (h)	120	130	140	150	160	170	180	190	200	220	240	260	280	300	330
rullo Ø 60 cm	13.5	13.5	14	14.3	15.1	15.1	15.6	16	16.5	16.7	17	17.3	18	18.5	19.6
rullo Ø 40 cm	12.7	12.7	13.6	13.6	14.5	14.5	15	15.3	15.7	16	17	17	17.8	18.3	19.2

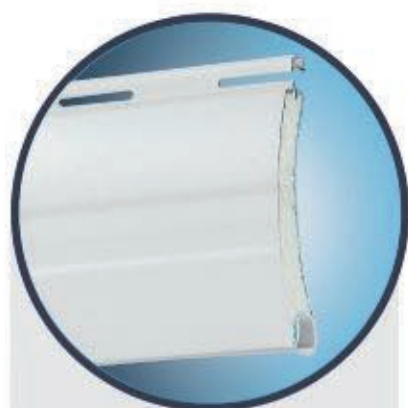

Peso al mq. Kg. 2,300 +-5%  
Larghezza massima cm. 250  
Altezza massima cm. 330  
Poliuretano Kg 70/90  
Spessore lamiera 0,30 mm

## AVVOLGIBILE IN ALLUMINIO 8x37

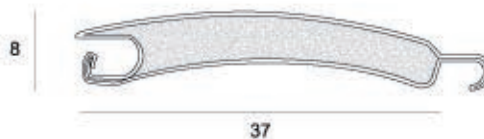

Codice	Descrizione
02037..	Avvolgibile in alluminio 8x37

### GUIDE COMPATIBILI

Codice	Descrizione
08084..	Guida in alluminio 20x25
08085..	Guida in alluminio 14x28 vedi catalogo a pg 35-36

tapparella in all. (h)	120	130	140	150	160	170	180	190	200	220	240	260	280	300	330
rotolo Ø 40 cm	11.5	12	12	12.6	13	13	13.5	13.6	14.1	14.8	15.1	15.6	16.1	16.6	17.2
rotolo Ø 60 cm	12.5	12.5	13	13	13.3	13.8	14	14.5	14.5	15	15.5	16.2	16.8	17.2	18

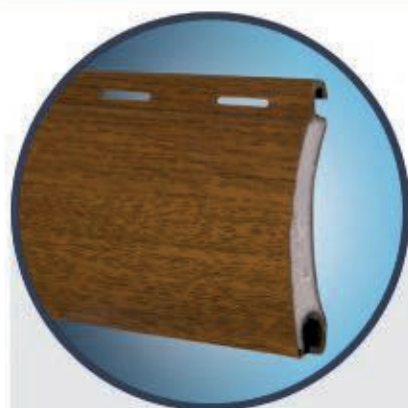

Peso al mq. Kg. 9,00 x mq. +-5% Densità Normale  
Peso al mq. Kg 10,500 x mq. Densità Alta  
Larghezza massima cm 420  
Altezza massima cm 330  
Poliuretano Kg 70/90 x mq. Densità Normale  
Poliuretano Kg 300/350 x mq. Densità Alta  
Spessore lamiera 0,48 mm

## AVVOLGIBILE IN ACCIAIO 12x55

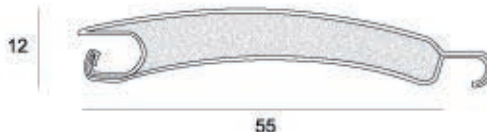

Codice	Descrizione
03055..	Avvolgibile in acciaio 12x55
03A55..	Avvolgibile in acciaio 12x55 con poliuretano ad alta densità
E3055..	Avvolgibile in acciaio 12x55 con tappo avvolgente
E3A55..	Avvolgibile alta densità 12x55 con tappo avvolgente

### GUIDE COMPATIBILI

Codice	Descrizione
08081..	Guida in alluminio 25x28
08082..	Guida in alluminio 20x30
08083..	Guida in alluminio 17x28 (non compatibile con tappo avvolgente) vedi catalogo a pg 35-36



TAPPO  
AVVOLGENTE

tapparella in all. (h)	120	130	140	150	160	170	180	190	200	220	240	260	280	300	330
ingombro Ø cm	16,5	17,2	17,5	18,2	18,5	19	19,5	19,5	20,2	20,7	21,5	22,7	23	24	25





Peso al mq. Kg. 8,500 x mq.  
Larghezza massima cm 350  
Altezza massima cm 330  
Poliuretano Kg 70/90 x mq.  
Spessore lamiera 0,48 mm

## AVVOLGIBILE IN ACCIAIO 9x42

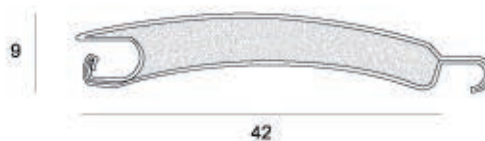

Codice	Descrizione
03043..	Avvolgibile in alluminio 9x42

### GUIDE COMPATIBILI

Codice	Descrizione
08084..	Guida in alluminio 20x25
08085..	Guida in alluminio 14x28

tapparella in all. (h)	120	130	140	150	160	170	180	190	200	220	240	260	280	300	330
ruolo Ø 40 cm	12,7	12,7	13,6	13,6	14,5	14,5	15	15,3	15,7	16	17	17	17,8	18,3	19,2
ruolo Ø 60 cm	13,5	13,5	14	14,3	15,1	15,1	15,6	16	16,5	16,7	17	17,3	18	18,5	19,6

## TERMINALI E CATENACCIOLI

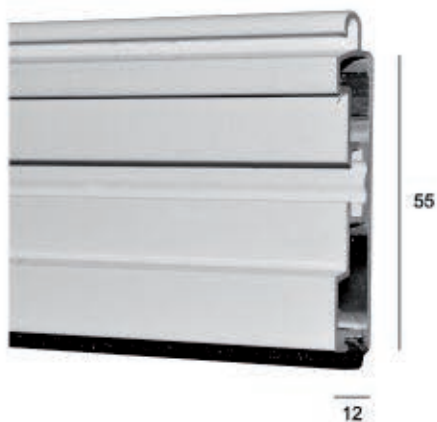

Codice	Descrizione
02002	Terminale in alluminio
02003	Terminale in plastica

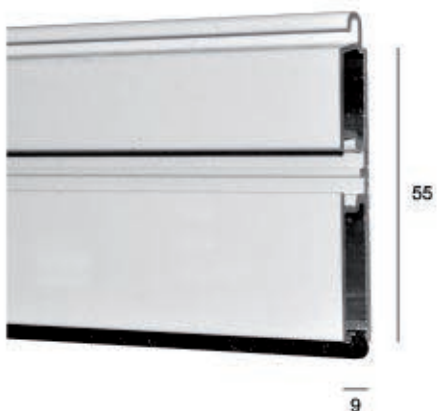
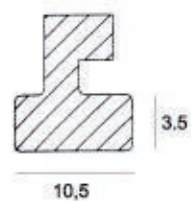

Codice	Descrizione
02T102..	Terminale in alluminio
BI	Bianco
AV	Avorio
NZ	Bronzo
MA	Marrone
AG	Argento



Codice	Descrizione
0200400	Catenacciolo per terminale



## TERMINALI E CATENACCIOLI



Codice	Descrizione
0200500	Catenacciolo intermedio



Codice	Descrizione
0708000	Blocco panzer 3 elementi



Codice	Descrizione
07MO000	Molla in acciaio

## CARTELLA COLORI ALLUMINIO

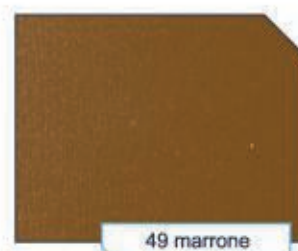
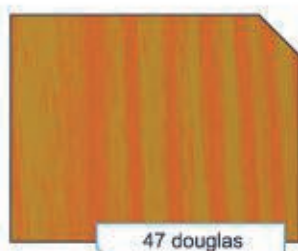
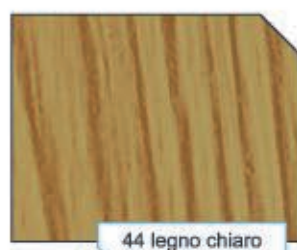
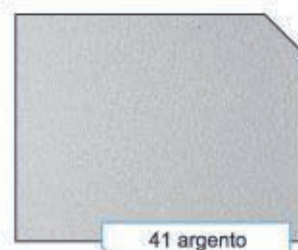
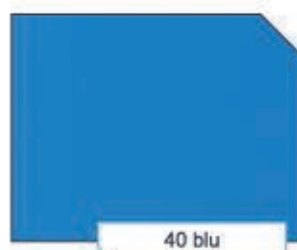
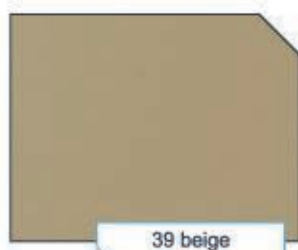
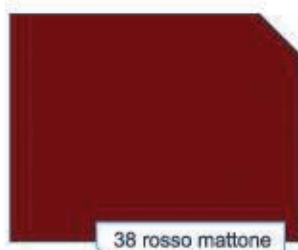

## CARTELLA COLORI ALLUMINIO

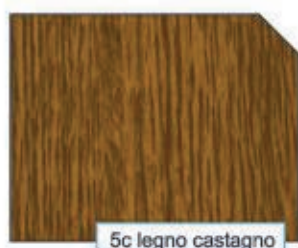

5c legno castagno



50 grigio raff



51 rosso raff



52 testadimoro



53 verde raff

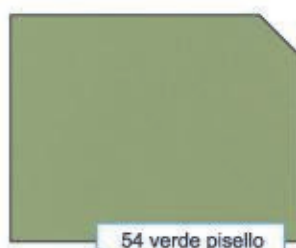

54 verde pisello



55 verde chiaro



56 marrone 8017



57 ciliegio



58 legno olmo

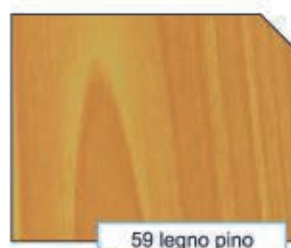

59 legno pino



60 Castagno Scuro

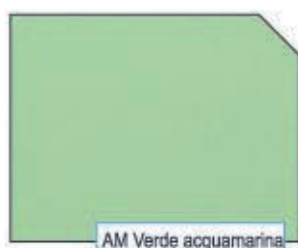

AM Verde acquamarina



CZ Carta da Zucchero



SA Sabbia

I colori stampati sono indicativi. Verificare sulle mazzette colori in alluminio.

\* Colori disponibili per il profilo in alluminio 02037.. (8x37)

## CARTELLA COLORI ACCIAIO



61 bianco



62 grigio

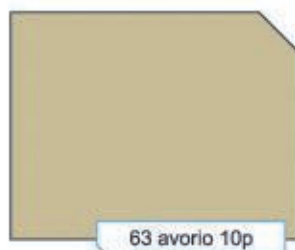

63 avorio 10p



64 avorio 1013

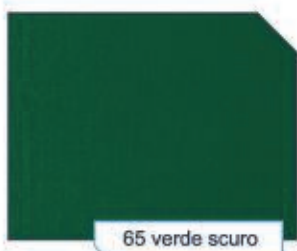

65 verde scuro



66 rosso matto

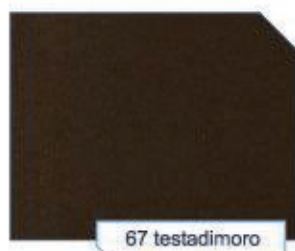

67 testadimoro



68 legnoscuero



69 rosso vivo

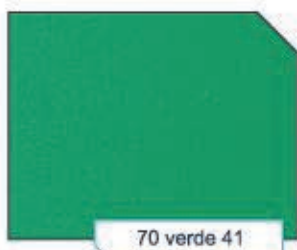

70 verde 41

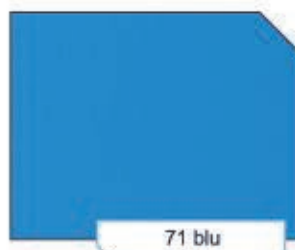

71 blu

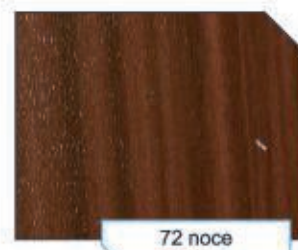

72 noce



73 giallo ocra

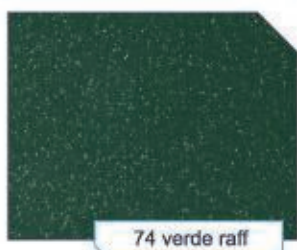

74 verde raff

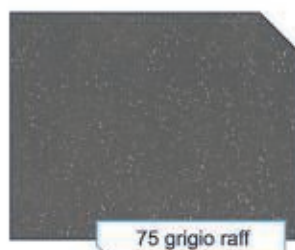

75 grigio raff



76 rosso raff



## CARTELLA COLORI ACCIAIO



77 testadimoro raff



78 marrone

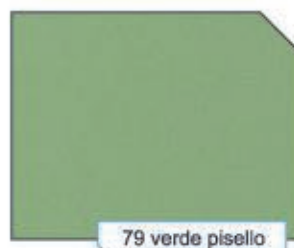

79 verde pisello



81 legno castagno



82 marrone 8017



83 grigio 35

I colori stampati sono indicativi. Verificare sulle mazzette colori in acciaio.

AVVOLGIBILI   
**D'ERRICO**

ARIALUCE

## AVVOLGIBILE ARIA LUCE

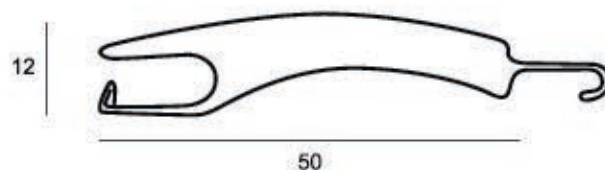
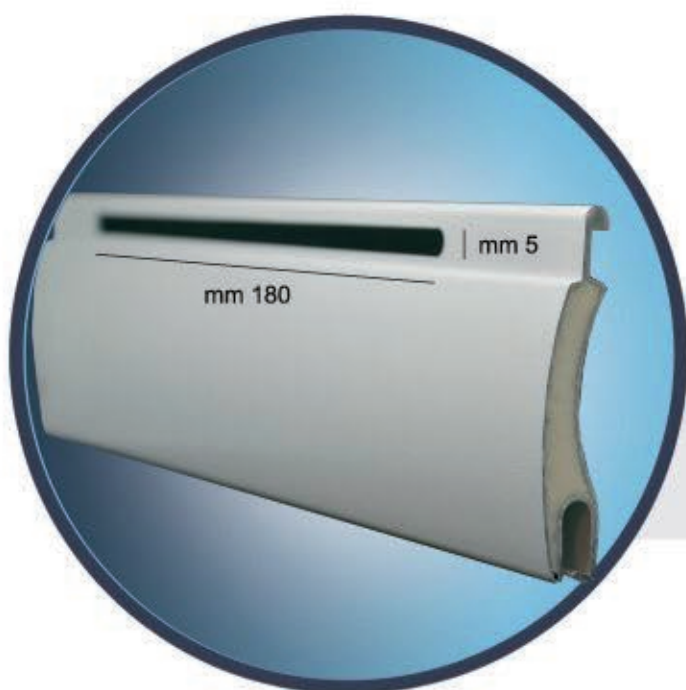

Peso al mq. Kg. 5,00 x mq. densità normale  
 Peso al mq. Kg. 6,00 x mq. alta densità  
 Larghezza massima cm 4200  
 Altezza massima cm 330  
 Spessore lamiera 0,5 mm

Codice	Descrizione
ALU00..	Avvolgibile ARIALUCE in alluminio
ALUAD..	Avvolgibile ARIALUCE in alluminio Alta Densità

GUIDE COMPATIBILI	
Codice	Descrizione
08081..	Guida in alluminio 25x31
08082..	Guida in alluminio 20x30
08083..	Guida in alluminio 17x28

h	120	130	140	150	160	170	180	190	200	210	220	230	240	250	260	270	280	290	300	330
ingombro Ø cm	15,5	15,5	16	17	17	17,5	18	19	19	20	20	20,5	20,5	21	21	22	22	23	23	24



## CARTELLA COLORI AVVOLGIBILE ARIA LUCE



31 Bianco



34 Avorio 1013



33 Avorio



32 Grigio



30 Grigio 35

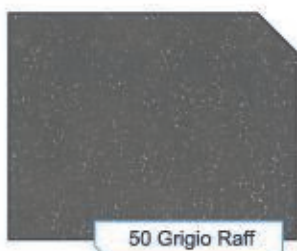

50 Grigio Raff



36 Verde Scuro



53 Verde Raff

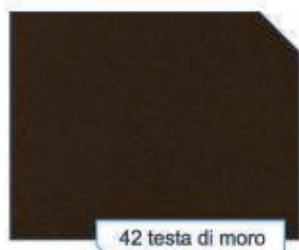

42 testa di moro



56 Marrone 8017



49 Marrone



48 Giallo Ocra



RM Renolit Miele



45 Legno Scuro

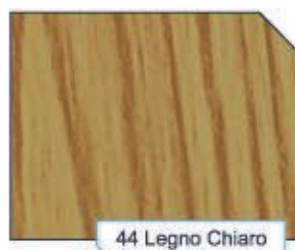

44 Legno Chiaro

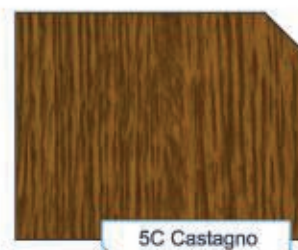

5C Castagno



38 Rosso Mattone

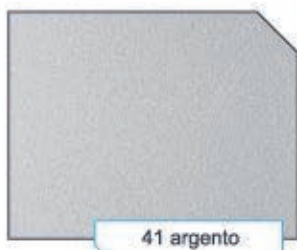

41 argento



LN Legno Noce



37 rosso vivo



AVVOLGIBILI   
**D'ERRICO**

SICURTAPP





Peso al mq. Kg. 13,00 x mq.  
Larghezza massima cm 370  
Altezza massima cm 330

## AVVOLGIBILE SICURTAPP MICROFORATA con catenaccioli automatici

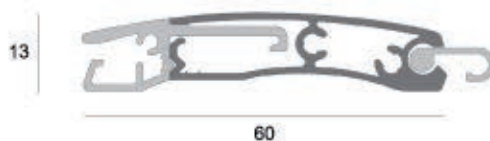

Di serie vengono fornite tre coppie di catenaccioli alle stecche 2, 7, 15

Codice	Descrizione
STP00..	Avvolgibile SICURTAPP in alluminio estruso
STPCA00	Catenacciolo aggiuntivo

### GUIDE COMPATIBILI

Codice	Descrizione
08S50..	Guida in alluminio 25x50

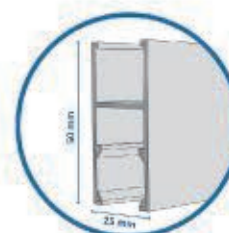

Codice	Descrizione
08SSA..	Guida in alluminio 25x50



tapparella in all. (h)	100	120	130	140	150	160	170	180	190	200	220	240	260	280	300	330
ruolo Ø 60 cm	15	16,5	17	17,5	18	18,5	19	19,5	19,5	20,5	21,5	22,5	23,5	24	24,5	25,5
ruolo Ø 70 cm	16	17,5	18	18,5	19	19,5	20	20,5	20,5	21,5	22,5	23,5	24,5	25	25,5	26,5

## CARTELLA COLORI AVVOLGIBILE SICURTAPP

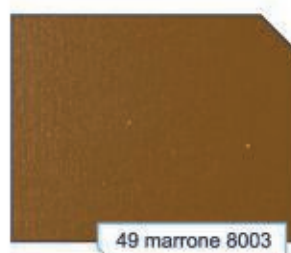
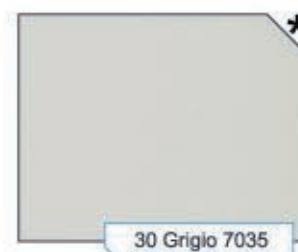



AVVOLGIBILI   
**D'ERRICO**

ACCESSORI

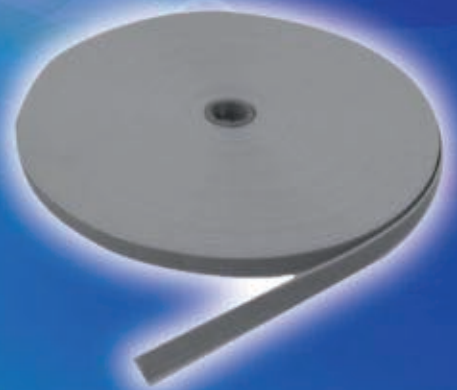

## AVVOLGITORI E PLACCHE

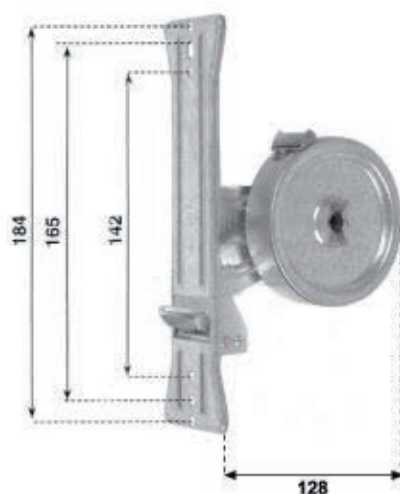

Codice	Descrizione
0400800	Avvolgitore da mt 6 tipo A

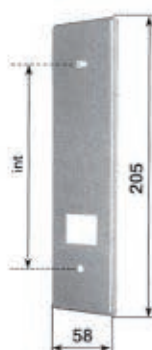

Codice	Descrizione
0402001	Placca in alluminio int. 14.2
0402101	Placca in alluminio int. 16.5
0402201	Placca in alluminio int. 18.5
0402002	Placca in alluminio int. 14.2 bronzo
0402003	Placca in acciaio inox int. 14.2



Codice	Descrizione
04VE0AG	Placca Venus argento
04VE0BI	Placca Venus bianco
04VE0AV	Placca Venus avorio
04VE0MA	Placca Venus marrone
04VE0OR	Placca Venus oro satinato

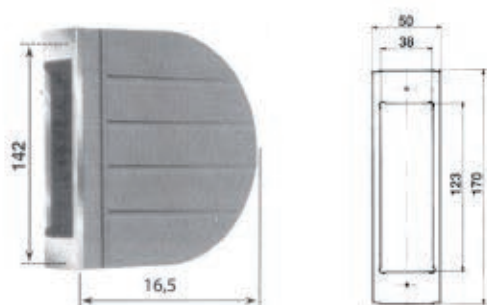

Codice	Descrizione
0404006	Cassetta in plastica mt 6

## AVVOLGITORI E PLACCHE

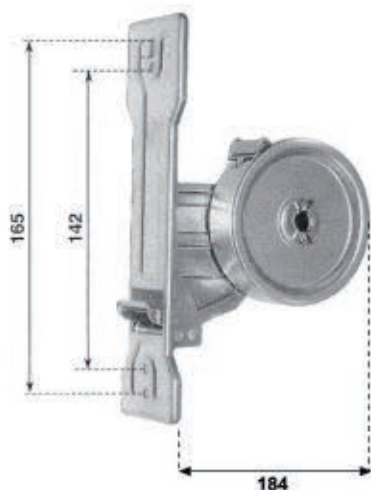

Codice	Descrizione
0400900	Avvolgitore da mt 12 tipo B

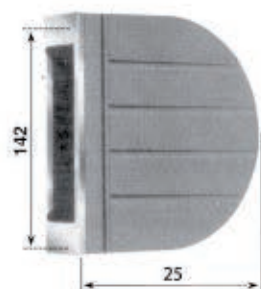

Codice	Descrizione
0404012	Cassetta in plastica mt 12

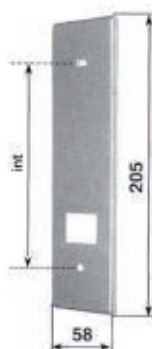

Codice	Descrizione
0402001	Placca in alluminio int. 14.2
0402002	Placca in alluminio int. 14.2 bronzo
0402003	Placca in acciaio inox int. 14.2



## AVVOLGITORI E PLACCHE

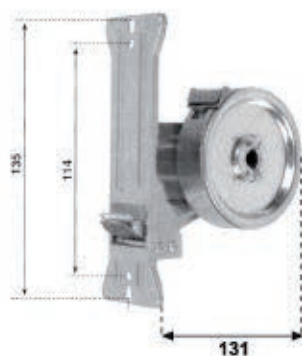

Codice	Descrizione
0400100	Avvolgitore da mt 6 tipo C



Codice	Descrizione
0411401	Placca tipo C in alluminio > int. 11.4
0413501	> int. 13.5
0411402	> int. 11.4 bronzo

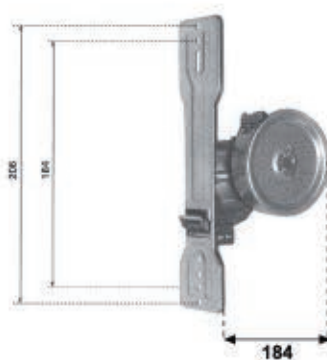

Codice	Descrizione
0400200	Avvolgitore da mt 12 tipo D



Codice	Descrizione
0418401	Placca in alluminio tipo D > int. 18.4
0420601	> int. 20.6
	disponibile in bronzo-inox

## AVVOLGITORI E PLACCHE



Codice	Descrizione
0400300	Avvolgitore a semincasso mt. 10 tipo E



Codice	Descrizione
0402400	Placca cromata tipo E



Codice	Descrizione
0400400	Avvolgitore a semincasso mt 5,5 tipo F

## AVVOLGITORI E PLACCHE

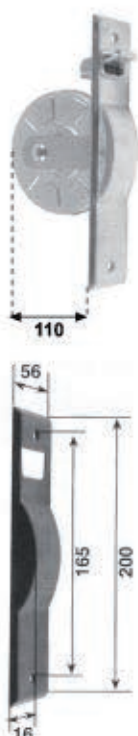

Codice	Descrizione
0400500	Avvolgitore a semincasso mt 5,5 tipo G

Codice	Descrizione
0402600	Placca semincasso all. nero tipo G



Codice	Descrizione
0400605	Avvolgitore a semincasso mt 5 tipo L
0400608	Avvolgitore a semincasso mt 8 tipo L



Codice	Descrizione
0402701	Placca in alluminio mt 5 tipo L
0402801	Placca in alluminio mt 8 tipo L
0402702	Placca in alluminio mt 5 tipo L bronzo
0402802	Placca in alluminio mt 8 tipo L bronzo



## AVVOLGITORI E PLACCHE



Codice	Descrizione
0400705	Avvolgitore a semincasso mt 5 tipo M
0400708	Avvolgitore a semincasso mt 8 tipo M

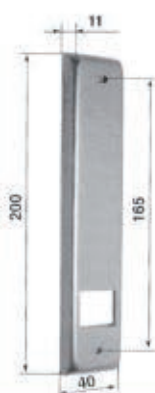

Codice	Descrizione
0402902	Placca larga per avvolgitore a semincasso mt 5 in alluminio bronzato
	disponibile in: > alluminio nero

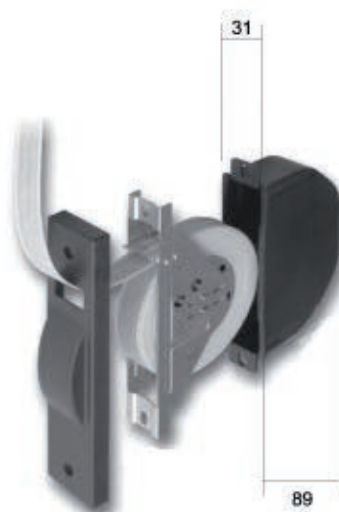

Codice	Descrizione
0401005	Avvolgitore a semincasso mt 5,5 tipo S
0401008	Avvolgitore a semincasso mt 8 tipo S

## AVVOLGITORI E PLACCHE

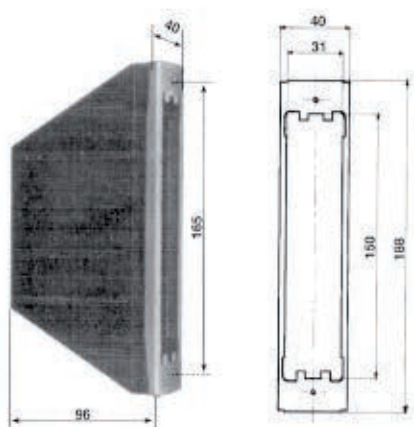

Codice	Descrizione
0404105	Cassetta per avvolgitore a semincasso tipo M - L mt 5

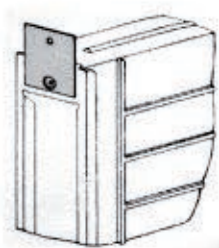

Codice	Descrizione
0404107	Cassetta per avvolgitore a semincasso tipo M - L attacco frontale

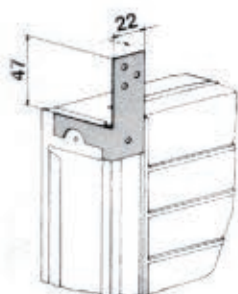

Codice	Descrizione
0404106	Cassetta per avvolgitore a semincasso tipo M - L attacco laterale

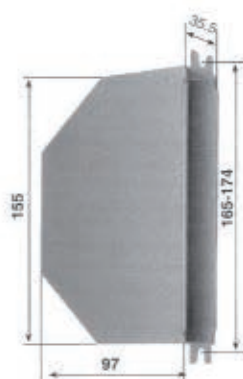

Codice	Descrizione
0404205	Cassetta per avvolgitore a semincasso tipo M - L mt 5
0404208	Cassetta per avvolgitore a semincasso tipo M - L mt 8

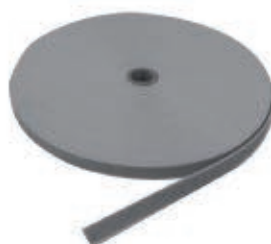

Codice	Descrizione
0706001	Cintino PP grigio
0706002	Cintino PP bicolore
0706003	Cintino in cotone grigio
0706004	Cintino in cotone bicolore extra

## AVVOLGITORI E PLACCHE



Codice	Descrizione
04010dx	avv. a cassonetto P destro
04010sx	avv. a cassonetto P sinistro
0500119	Puleggia per avv. tipo P

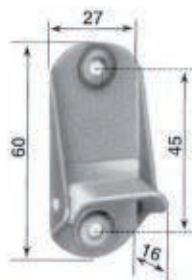

Codice	Descrizione
0701001	Bloccantino per avvolgitore tipo P zincato
0701002	Bloccantino per avvolgitore tipo P bronzo

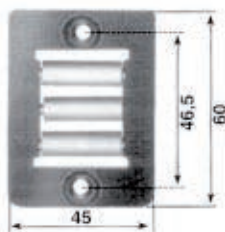

Codice	Descrizione
0701101	Guidacinta 3 rulli per avvolgitori P zincato
0701102	Guidacinta 3 rulli per avvolgitori P bronzo



## RULLI, PULEGGE E CALOTTE



Codice	Descrizione
0507050	Rullo in ferro 5/10 da mt 6
0507T50	Rullo in ferro 5/10 tagliato
0507010	Rullo in ferro 10/10 da mt 6
0507T10	Rullo in ferro 10/10 tagliato

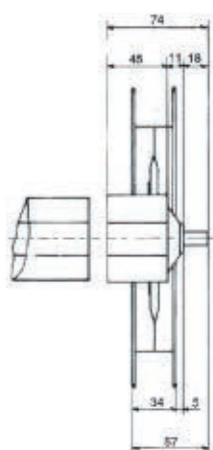

Codice	Descrizione
0500218	Puleggia in ferro $\varnothing$ 18
0500220	Puleggia in ferro $\varnothing$ 20
0500222	Puleggia in ferro $\varnothing$ 22

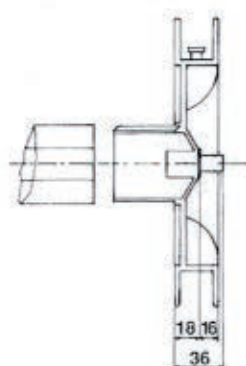

Codice	Descrizione
0500518	Puleggia in plastica perno a filo $\varnothing$ 18
0500520	Puleggia in plastica perno a filo $\varnothing$ 20

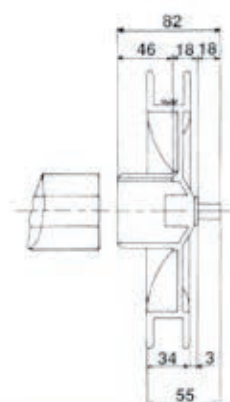

Codice	Descrizione
0500618	Puleggia in plastica perno esterno $\varnothing$ 18
0500620	Puleggia in plastica perno esterno $\varnothing$ 20

## RULLI, PULEGGE E CALOTTE

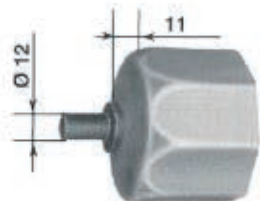

Codice	Descrizione
0504000	Calotta per rullo zincata

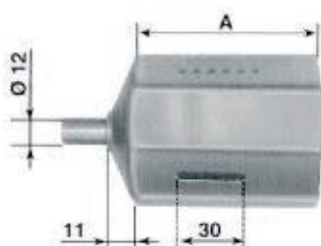

Codice	Descrizione
0504100	Calotta registrabile

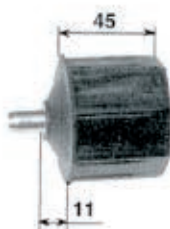

Codice	Descrizione
0504200	Calotta in plastica



Codice	Descrizione
0504360	Calotta in plastica
0504370	Calotta in plastica Ø70

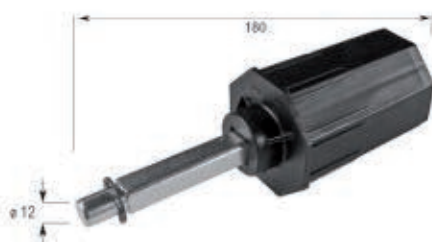

Codice	Descrizione
0504460	Calotta in plastica con molla

## RULLI, PULEGGE E CALOTTE



Codice	Descrizione
0500720	Riduttore Portata 40 Kg Ø 20

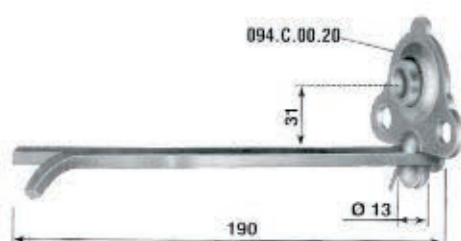

Codice	Descrizione
0600700	Supporto per riduttore



## SUPPORTI

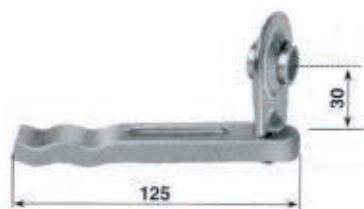

Codice	Descrizione
0600100	Supporto tipo E

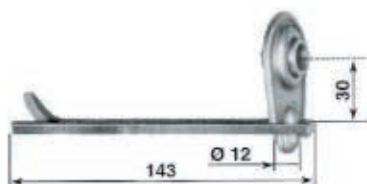

Codice	Descrizione
0600200	Supporto a murare rinf. tipo A



Codice	Descrizione
0600311	Supporto a legno piega 11
0600345	Supporto a legno piega 45
06CUS00	Cuscinetto per supporto a cassonetto

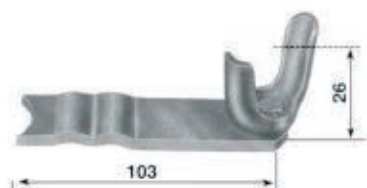

Codice	Descrizione
0600400	Supporto a murare rinf. tipo C



Codice	Descrizione
0600500	Cuscinetto per tipo C e per bifora

## SUPPORTI



Codice	Descrizione
0600600	Supporto tipo S completo

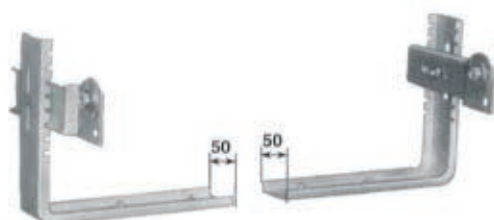

Codice	Descrizione
0600800	Supporto tipo L completo



Codice	Descrizione
0600900	Supporto per bifora

## GUIDACINTA E ACCESSORI VARI

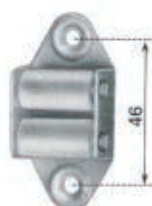

Codice	Descrizione
0700100	Guidacinta



Codice	Descrizione
0700200	Guidacinta trasversale

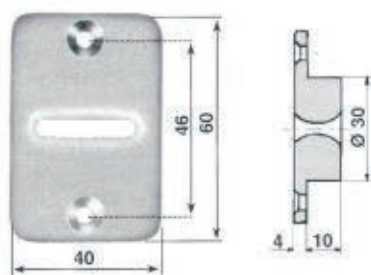

Codice	Descrizione
07003BI	Guidacinta plastica Bianco
07003MA	Guidacinta plastica Marrone
07003NE	Guidacinta plastica Nero

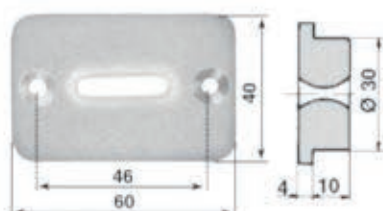

Codice	Descrizione
07004BI	Guidacinta plastica trasversale Bianco
07004MA	Guidacinta plastica trasversale Marrone
07004NE	Guidacinta plastica trasversale Nero



## GUIDACINTA E ACCESSORI VARI



Codice	Descrizione
07020BI	Tappo d'arresto Marrone
07020MA	
07020GR	Tappo d'arresto Grigio
07024BI	Tappo d'arresto mm 40 Bianco



Codice	Descrizione
0703000	Rullino di rinvio



Codice	Descrizione
0703100	Rullino di rinvio regolabile

## GUIDACINTA E ACCESSORI VARI



Codice	Descrizione
0704000	Gancio di attacco al rullo

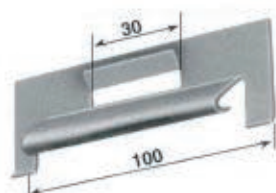

Codice	Descrizione
0704100	Gancio per avvolgibile



Codice	Descrizione
0705000	Antifurto a baionetta

## GUIDACINTA E ACCESSORI VARI

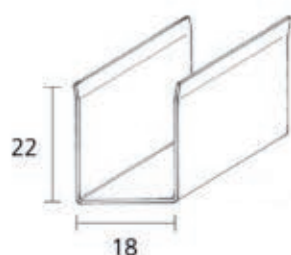

Codice	Descrizione
0808T00	Guida in ferro tagliata, spaccata e forata
0808000	guida in ferro da mt 6,00

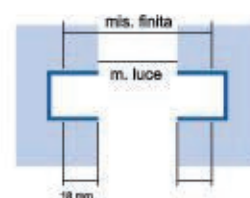

Codice	Descrizione
08T81..	Guida in alluminio tagliata, spaccata e forata 25x31
08081..	Guida in al. da mt. 6,5 25x31
BI	BIANCA 9010
AV	AVORIO 1013
NZ	BRONZO
MA	MARRONE 8017
AG	ARGENTO
	per avvolgibili 12x55

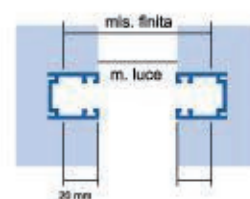

Codice	Descrizione
08T82..	Guida in alluminio tagliata, spaccata e forata 20x30
08082..	Guida in al. da mt. 6,5 20x30
BI	BIANCA 9010
AV	AVORIO 1013
NZ	BRONZO
NE	NERA
MA	MARRONE 8017
AG	ARGENTO
	per avvolgibili 12x55

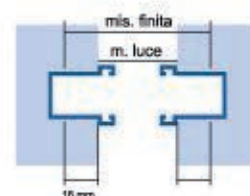



## GUIDACINTA E ACCESSORI VARI



Codice	Descrizione
08T83..	Guida in alluminio tagliata, spaccata e forata 17x28
08083..	Guida in al. da mt. 6,5 17x28
BI	BIANCA 9010
AV	AVORIO 1013
NZ	BRONZO
MA	MARRONE 8017
AG	ARGENTO
	per avvolgibili 12x55

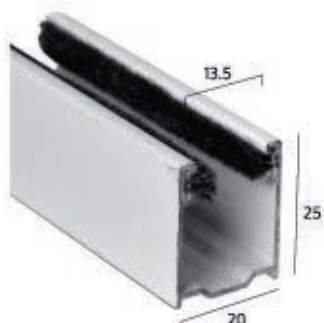
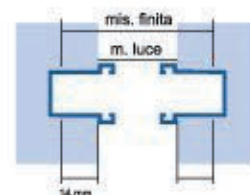

Codice	Descrizione
08T84..	Guida in alluminio tagliata, spaccata e forata 20x25
08084..	Guida in al. da mt. 6,5 20x25
BI	BIANCA 9010
AV	AVORIO 1013
NZ	BRONZO
MA	MARRONE 8017
AG	ARGENTO
	per avvolgibili 9x45/8x37/9x42

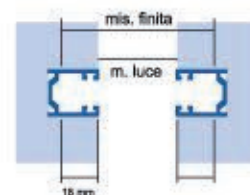

Codice	Descrizione
08T85..	Guida in alluminio tagliata, spaccata e forata 14x28
08085..	Guida in al. da mt. 6,5 14x28
BI	BIANCA 9010
AV	AVORIO 1013
NZ	BRONZO
NE	NERA
MA	MARRONE 8017
AG	ARGENTO
	per avvolgibili 9x45/8x37/9x42

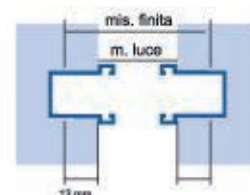

## ARGANELLI



Codice	Descrizione
0900100	Arganello a fune



Codice	Descrizione
0900200	Cassetta in plastica per arganello



Codice	Descrizione
0900300	Placca per arganello

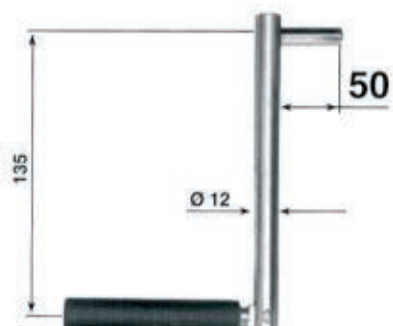

Codice	Descrizione
0900400	Manovella snodata cromata

## ARGANELLI

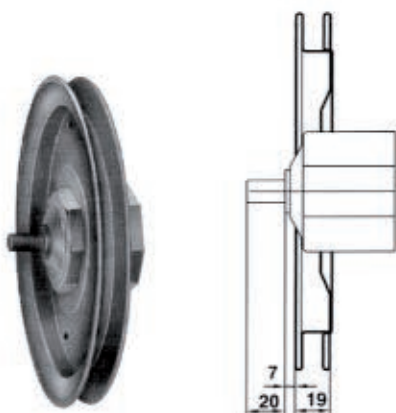

Codice	Descrizione
09PUL20	Puleggia per arganello



Codice	Descrizione
0900500	Snodo

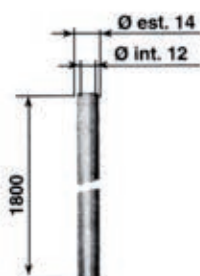

Codice	Descrizione
0900600	Guaina



Codice	Descrizione
0900718	Cavetto Ø 18 da mt 100
0900725	Cavetto Ø 25 da mt 100
090T718	Cavetto Ø 18 tagliato
090T725	Cavetto Ø 25 tagliato



## ARGANI AD ASTA

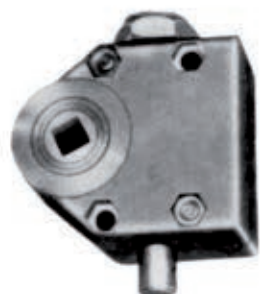

Codice	Descrizione
1000100	Argano ad asta

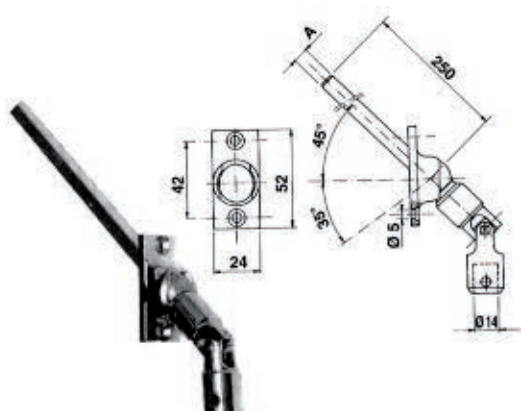

Codice	Descrizione
1004000	Snodo

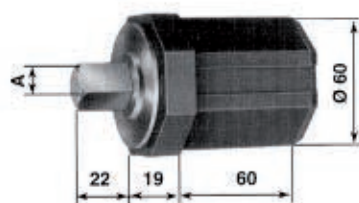

Codice	Descrizione
1006000	Calotta con finecorsa



Codice	Descrizione
1007000	Asta
1008000	Fermacorsa

## ARGANI A CORDA

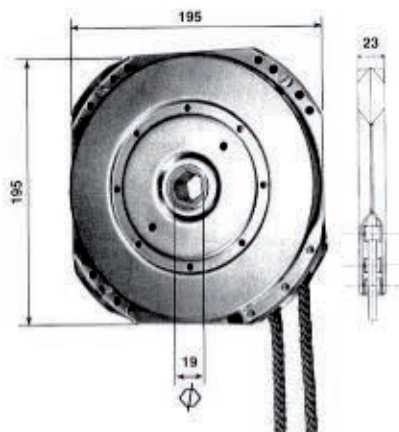

Codice	Descrizione
11001BI	Argano a corda Bianco
11001GR	Argano a corda Grigio

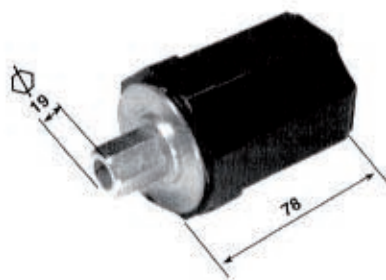

Codice	Descrizione
11020dx	Calotta con finecorsa destra
11020sx	Calotta con finecorsa sinistra

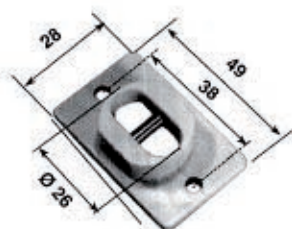

Codice	Descrizione
1103000	Guidacordone



Codice	Descrizione
1104000	Fermacordone



Codice	Descrizione
1100500	Argano a corda tipo B - kit dx
11005sx	Argano a corda tipo B - kit sx

## TELAI A SPORGERE



Codice	Descrizione
1200100	Telaio a sporgere zincato (leve laterali)



Codice	Descrizione
1202000	Telaio a sporgere zincato (leva centrale)

## TELAI A SPORGERE



Codice	Descrizione
1203000	Telaio a sporgere in alluminio (leve laterali)



Codice	Descrizione
1204000	Telaio a sporgere in alluminio (leva centrale)



AVVOLGIBILI   
**D'ERRICO**

MOTORIDUTTORI



## MOTORIDUTTORI

5 anni di garanzia



Codice	Descrizione	Nr.	Portata	Velocità gir/min	Potenza W	Assorbimento	L
1600020	Motoriduttore	20	30	17	145	0,64	449
1600030		30	45	17	191	0,83	519
1600050		50	70	15	205	0,89	519

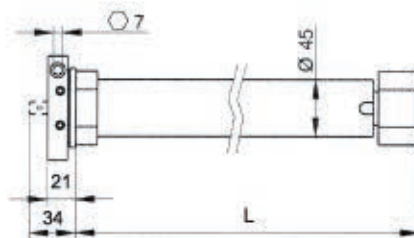

Made in Italy

Codice	Descrizione	Nr.	Portata	Velocità gir/min	Potenza W	Assorbimento	L
130CM15	Motoriduttore con manovra	15	28-24	13	125	0,55	583
130CM27		27	50-42	13	190	0,85	583
130CM35		35	65-55	13	230	1,05	633
130CM45		45	83-71	13	290	1,30	633
130CM80		80	116	12	375	1,70	690
130CM100		100	146	12	410	1,85	690
130CM130		120	189	9	410	1,85	690

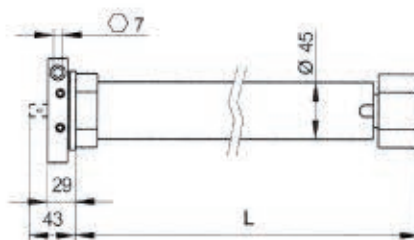



## MOTORIDUTTORI



Made in Italy

Codice	Descrizione	Nr.	Portata	Velocità giri/min	Potenza W	Assorbimento	L
1300015	Motoriduttore	15	28-24	13	125	0,55	473
1300027		27	50-42	13	190	0,85	533
1300035		35	65-55	13	230	1,05	583
1300045		45	83-71	13	290	1,30	583
1300080		80	116	12	375	1,70	640
13000100		100	146	12	410	1,85	640
13000130		120	189	9	410	1,85	640

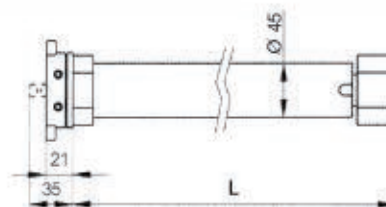

Fornibili anche con radiorecevente incorporata



Codice	Descrizione
120AD01	Adattatore

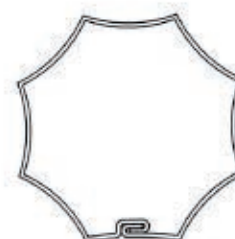

Codice	Descrizione
120AD02	Adattatore

Disponibili anche altri adattatori (specificare il tipo di rullo)

## ACCESSORI PER MOTORIDUTTORI

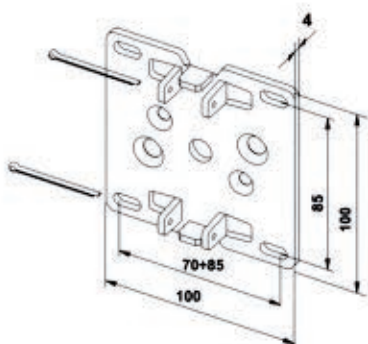

Codice	Descrizione
13SUP01	Supporto (per 13000..)

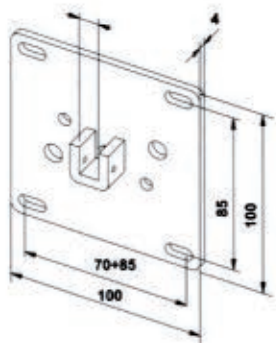

Codice	Descrizione
13SUP02	Supporto

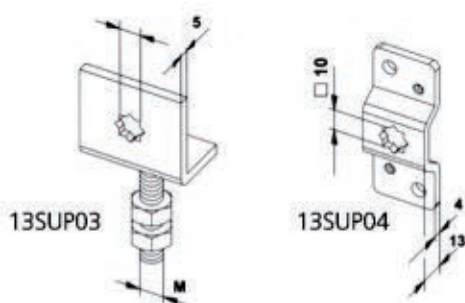

Codice	Descrizione
13SUP03	Supporto
13SUP04	Supporto

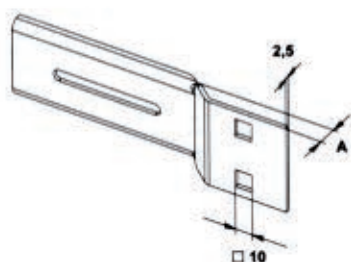

Codice	Descrizione
13SUP05	Supporto



## ACCESSORI PER MOTORIDUTTORI



Codice	Descrizione
13SNO01	Snodo

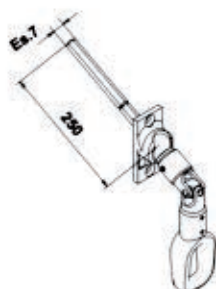

Codice	Descrizione
13SNO02	Snodo



Codice	Descrizione
13AST01	Asta con gancio per art. 13SNO02
13AST02	Asta per esagono
13AST12	Esagono per art. 13AST02

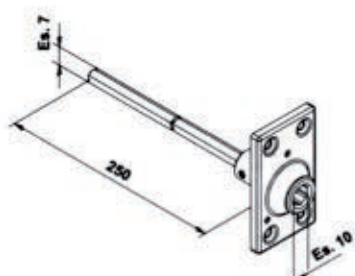

Codice	Descrizione
13SNO03	Snodo con foro per art. 13AST12

AVVOLGIBILI   
**D'ERRICO**

PROFILI TECNICI  
IN PVC

## PROFILI TECNICI

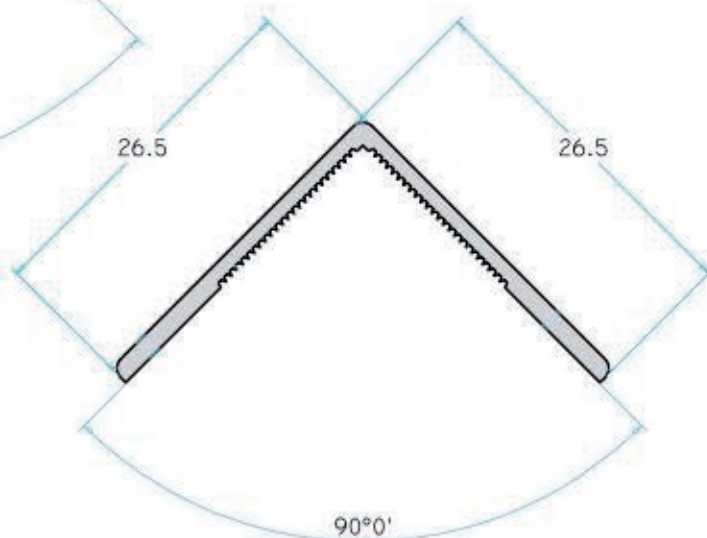
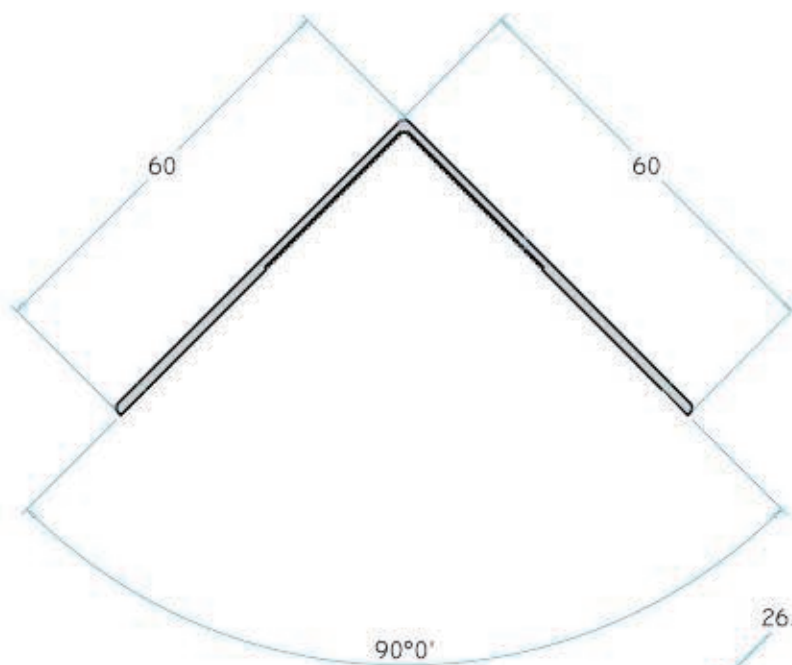
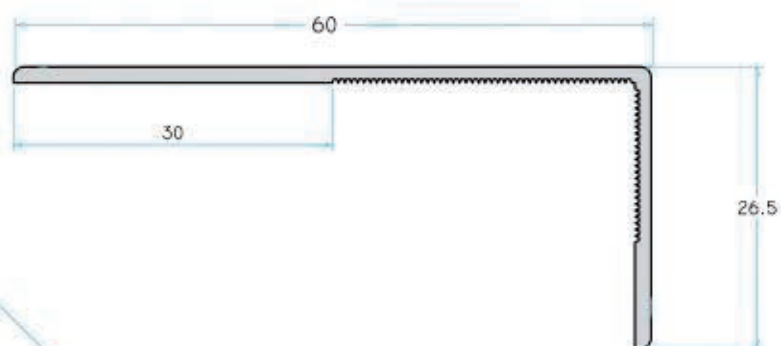
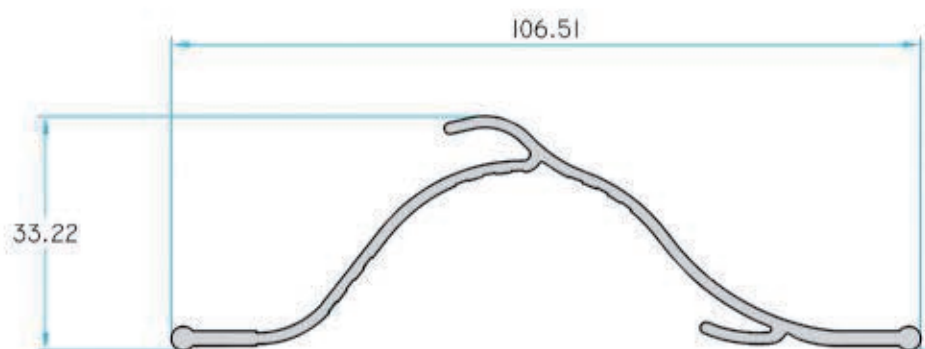

## PROFILI TECNICI

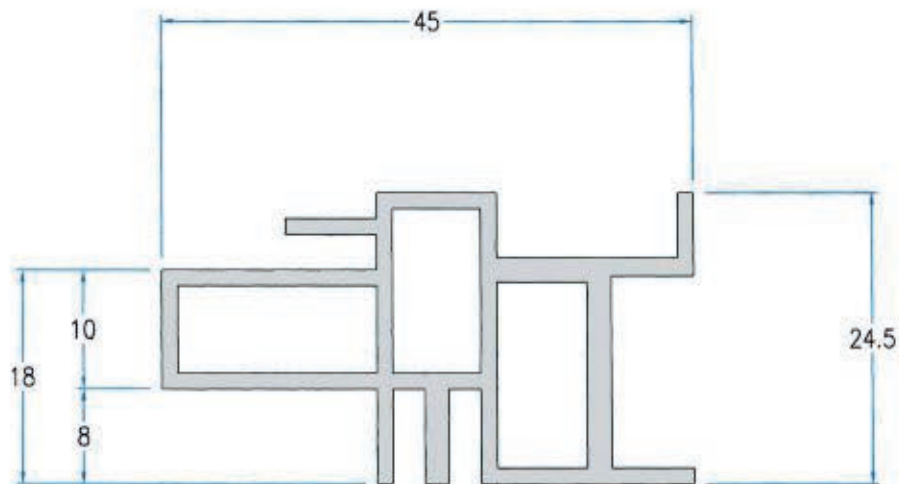
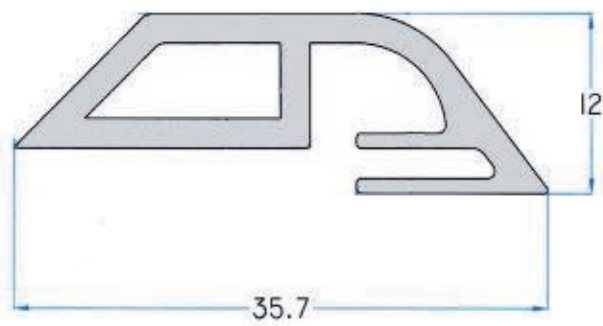
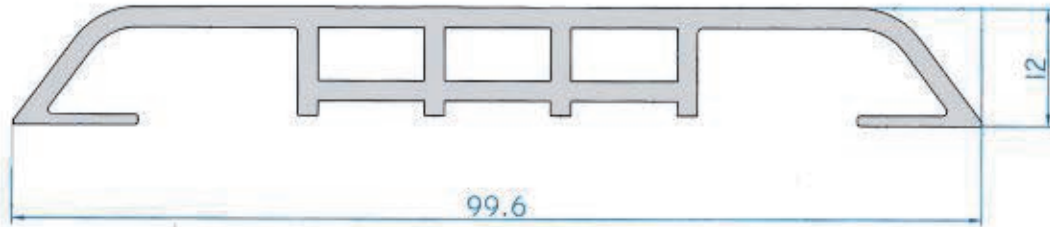







SAN SEVERO (FG) - Via Foggia Z.I.  
Tel. +39.0882.22.53.11  
[www.derricoavvolgibili.com](http://www.derricoavvolgibili.com)  
[info@derricoavvolgibili.com](mailto:info@derricoavvolgibili.com)